

# DEVELON

## Crawler Excavator

# DX490LC-7



### Engine

Make	Scania
Model	DC13
Number of cylinders	6
Rated power, gross (hp per SAE J1995)	394.3 hp (294 kW) @ 1800 rpm
Rated power, net (hp per SAE J1349)	387.6 hp (289 kW) @ 1800 rpm
Max. torque, net (SAE J1995)	1373 lbf.ft. (1863 Nm) @ 900 rpm
Displacement	775 in. <sup>3</sup> (12.7 L)
Bore and stroke	5.1 in. x 6.3 in. (130 mm x 160 mm)
Starter	24 V, 8.0 hp (6.0 kW)
Battery	2 x 12 V, 200 AH, 1300 CCA
Alternator	28 V, 100 amp
Air cleaner	Three-stage

### Hydraulics

Main pumps	2 x 103 gpm (2 x 390 L/min.)
Pilot pump (gear design)	6.3 gpm (24 L/min.)
Relief pressure (normal mode)	4694 psi (330 kg/cm <sup>2</sup> )
Relief pressure (power boost)	4978 psi (350 kg/cm <sup>2</sup> )

### Working Pressure

Boom/arm/bucket (normal mode)	4694 psi (330 kg/cm <sup>2</sup> )
Boom/arm/bucket (power boost)	4980 psi (350 kg/cm <sup>2</sup> )
Travel	4694 psi (330 kg/cm <sup>2</sup> )
Swing	4267 psi (300 kg/cm <sup>2</sup> )

### Undercarriage

Upper rollers (each track)	US20 & US30: 3 for retractable tracks US25: 2 for fixed track	
Lower rollers (each track)	9	
Number of shoes (links per side)	53	
Total length of track	retractable	17' 10" (5455 mm)
	fixed	17' 11" (5465 mm)

### Swing Mechanism

Swing speed	0 – 9.2 rpm
Swing torque	145600 lbf.ft. (20130 kgf-m)

### Drive System

Travel speed (low – high)	1.9 – 3.4 mph (3.2 – 5.6 km/h)
Traction force, max. (drawbar pull)	100751 lbf.ft. (45700 kgf-m)
Max. grade (limited by engine lub)	70% (35°)

### Environment

Sound level (2000/14/EC)	106 dB(A)
Cabin sound level (ISO 6396)	72 dB(A)

### Refill Capacities

Fuel tank	165.3 gal. (626 L)
DEF tank	18.5 gal. (70 L)
Cooling system (radiator capacity)	14.3 gal. (54.1 L)
Engine oil (with filler)	11.8 gal. (45 L)
Swing drive	2 x 1.3 gal. (2 x 5 L)
Final drive (each side)	2.4 gal. (9 L)
Hydraulic system	103 gal. (390 L)
Hydraulic tank	70 gal. (265 L)

### Hydraulic Cylinders

Boom <sup>1</sup> (2) bore x rod diameter x stroke	Mono boom	6.7 in. x 4.5 in. x 65.0 in. (170 mm x 115 mm x 1650 mm)
	2-PC boom (lower)	–
	2-PC boom (upper)	–
Arm <sup>1,2</sup> (1) bore x rod diameter x stroke		7.5 in. x 5.1 in. x 78.0 in. (190 mm x 130 mm x 1980 mm)
Bucket <sup>1</sup> (1) bore x rod diameter x stroke	STD	6.7 in. x 4.5 in. x 52.8 in. (170 mm x 115 mm x 1341 mm)
	SLR	–

<sup>1</sup> Cushion on rod end

<sup>2</sup> Cushion on base end

The piston rods and cylinder bodies are made of high-strength steel. A shock-absorbing mechanism is fitted in all cylinders to ensure shock-free operation and extended piston life.

NOTE: Where applicable, dimensions are in accordance with Society of Automotive Engineers (SAE) and ISO standards. Specifications and design are subject to change without notice. All dimensions are given for DEVELON excavators equipped with standard tracks and the standard front as listed. Pictures of DEVELON excavators may show other than standard equipment. All dimensions are shown in inches. Respective metric dimensions are enclosed by parentheses. Rounding may impact specifications. DEVELON equipment is manufactured with a Quality Management System that is in compliance with ISO 9001:2008.

# Dimensions

		Standard Arm 35.4" (900 mm) TG Shoe (US20)	Standard Arm 35.4" (900 mm) TG Shoe (US25)	Long Arm 35.4" (900 mm) TG Shoe (US30)
Boom length		23' 4" (7100 mm)		
Arm length		11' 0" (3350 mm)		13' 1" (3980 mm)
Bucket type (SAE)		2.80 yd <sup>3</sup> (2.14 m <sup>3</sup> )		2.35 yd <sup>3</sup> (1.80 m <sup>3</sup> )
Track type		Retractable	Fixed	Retractable
Tail swing radius	A <sub>1</sub>	12' 6" (3800 mm)		
Tail swing overhang (rear)	A <sub>2</sub>	3' 6" (1073 mm)	3' 6" (1068 mm)	3' 6" (1073 mm)
Tail swing overhang (side)	A <sub>3</sub>	6' 1" (1865 mm)	6' 6" (1975 mm)	6' 1" (1865 mm)
Shipping height (boom)	B	11' 9" (3580 mm)	11' 10" (3610 mm)	12' 6" (3800 mm)
Shipping height (hose)	C	12' 2" (3705 mm)		12' 10" (3910 mm)
Shipping length	D	40' 1" (12230 mm)	40' 3" (12280 mm)	40' 5" (12310 mm)
Shipping width	E	10' 10" (3290 mm)	12' 0" (3650 mm)	10' 10" (3290 mm)
Counterweight clearance*	F	4' 8" (1430 mm)	4' 2" (1280 mm)	4' 8" (1430 mm)
Cabin height	G	11' 0" (3350 mm)	10' 6" (3200 mm)	11' 0" (3350 mm)
Upper structure width	without catwalks	9' 10" (2900 mm)		
	with catwalks	10' 10" (3296 mm)		
Cabin height above house	I	2' 9" (845 mm)		
Cabin width	J	3' 4" (1010 mm)		
Tumbler distance	K	14' 8" (4475 mm)		
Overall track length	L	17' 11" (5455 mm)	17' 11" (5465 mm)	17' 11" (5455 mm)
Undercarriage width	retracted	11' 1" (3370 mm)	-	11' 1" (3370 mm)
	extended	12' 8" (3870 mm)	12' 0" (3650 mm)	12' 8" (38700 mm)
Track gauge	retracted	8' 1" (2470 mm)	-	8' 1" (2470 mm)
	extended	9' 9" (2970 mm)	9' 0" (2750 mm)	9' 9" (2970 mm)
Track shoe width	O	2' 11" (900 mm)		
Track height*	P	3' 10" (1180 mm)	3' 6" (1070 mm)	3' 10" (1180 mm)
Car body clearance*	Q	2' 5" (730 mm)	1' 9" (530 mm)	2' 5" (730 mm)

\*Without grouser height (36 mm)

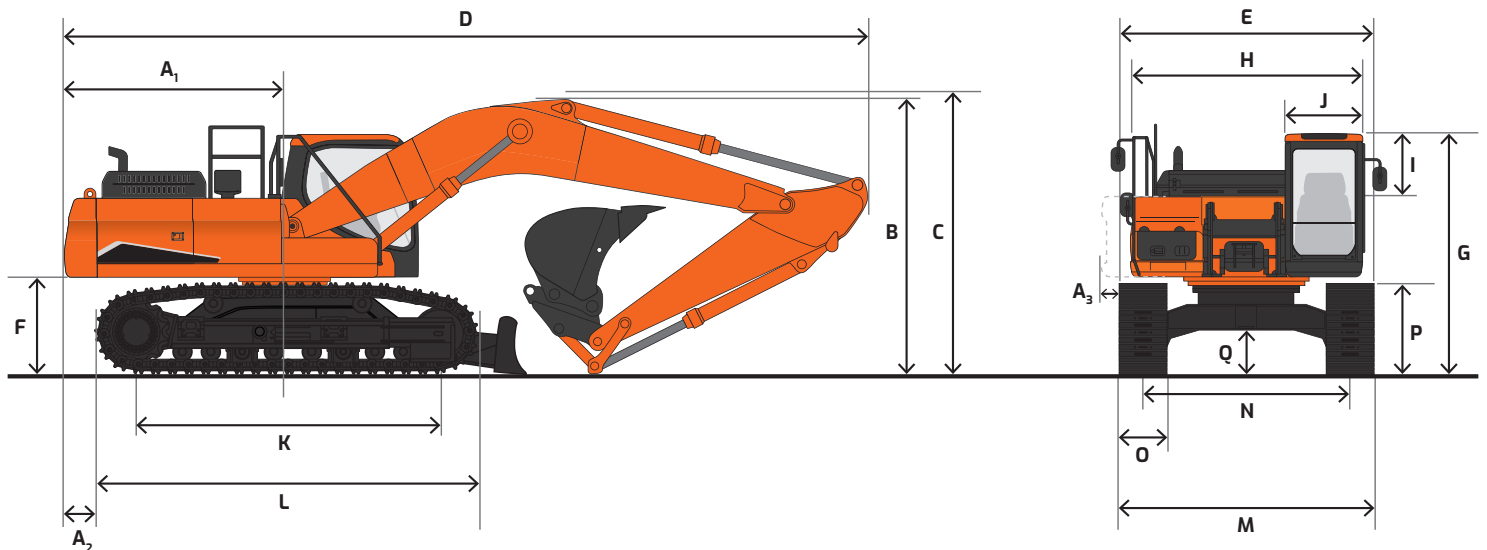

# Working Range

		Standard Arm 35.4" (900 mm) TG Shoe (US20)	Standard Arm 35.4" (900 mm) TG Shoe (US25)	Long Arm 35.4" (900 mm) TG Shoe (US30)
Boom length		23' 4" (7100 mm)		
Arm length		11' 0" (3350 mm)		13' 1" (3980 mm)
Bucket type (SAE, PCSA)		2.80 yd <sup>3</sup> (2.14 m <sup>3</sup> )		2.35 yd <sup>3</sup> (1.80 m <sup>3</sup> )
Track type		Retractable	Fixed	Retractable
Max. digging reach	A	39' 9" (12125 mm)		41' 7" (12670 mm)
Max. digging reach (ground)	B	38' 11" (11865 mm)	39' 0" (11895 mm)	40' 9" (12425 mm)
Max. digging depth	C	25' 7" (7790 mm)	26' 1" (7940 mm)	27' 7" (8405 mm)
Max. loading height	D	25' 10" (7865 mm)	25' 4" (7715 mm)	26' 4" (8025 mm)
Min. loading height	E	10' 3" (3130 mm)	9' 9" (2980 mm)	8' 3" (2510 mm)
Max. digging height	F	36' 3" (11050 mm)	35' 9" (10900 mm)	36' 9" (11205 mm)
Max. bucket pin height	G	31' 9" (9690 mm)	31' 4" (9540 mm)	32' 4" (9850 mm)
Max. vertical wall depth	H	14' 4" (4370 mm)	14' 10" (4520 mm)	16' 2" (4930 mm)
Max. radius vertical	I	32' 9" (9970 mm)		33' 7" (10235 mm)
Max. depth to 8' line	J	25' 1" (7635 mm)	25' 6" (7785 mm)	27' 1" (8265 mm)
Min. radius to 8' line	K	12' 9" (3895 mm)		12' 10" (3905 mm)
Min. digging reach	L	2' 9" (840 mm)	3' 6" (1055 mm)	2' 0" (50 mm)
Min. swing radius	M	17' 1" (5210 mm)		
Bucket angle (DEG)	d	189.1°		180.9°
Digging force, bucket (PCSA)*	ISO	65920 lbf. (29900 kgf)		67900 lbf. (30800 kgf)
Digging force, arm*		50485 lbf. (22900 kgf)		45195 lbf. (20500 kgf)
Operating weight		111554 lb. (50600 kg)	106924 lb. (48500 kg)	111113 lb. (50400 kg)
Ground pressure		9.1 psi (0.64 kg/cm <sup>2</sup> )	8.7 psi (0.61 kg/cm <sup>2</sup> )	9.1 psi (0.64 kg/cm <sup>2</sup> )

\*With power boost ON

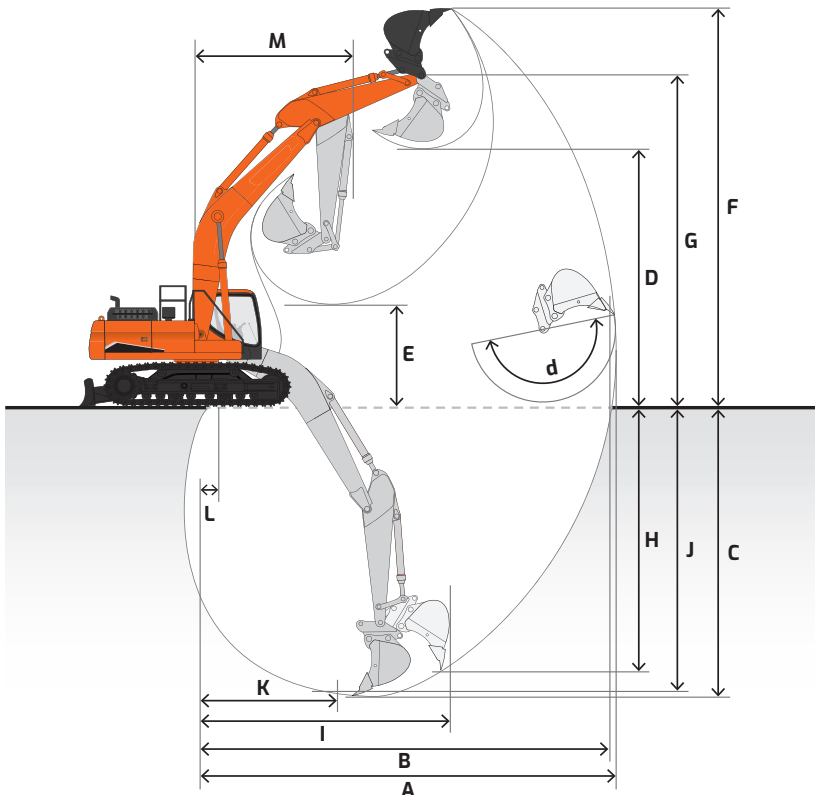













# Lifting Capacity

 Rating over front     Rating over side or 360°

## DX490LC-7 US20

Boom: 23' 4" (7100 mm) | Arm: 11' 0" (3350 mm) | Removable counterweight: 24420 lb. (11100 kg) | 35.4" (900 mm) TG Shoes | Bucket: None | Unit: lb. (kg)

A (ft. or m) B (ft. or m)	10' (3.0 m)		15' (4.5 m)		20' (6.0 m)		25' (7.5 m)		30' (9.0 m)		Max. Reach		
													
30' (9.0 m)							* 24150 (* 10620)	* 24150 (* 10620)			* 18740 (* 8370)	* 18740 (* 8370)	25.97' (7.81 m)
25' (7.5 m)							* 24160 (* 10920)	* 24160 (* 10920)			* 17780 (* 8090)	* 17780 (* 8090)	29.4' (8.87 m)
20' (6.0 m)							* 25790 (* 11600)	* 25790 (* 11600)	* 24000 (* 10850)	21670 (8810)	* 17520 (* 7950)	* 17520 (* 7950)	31.7' (9.61 m)
15' (4.5 m)			* 45500 (* 20120)	* 45500 (* 20120)	* 33940 (* 15160)	* 33940 (* 15160)	* 28310 (* 12720)	27910 (11370)	* 25150 (* 11350)	21170 (8600)	* 17770 (* 8040)	17610 (7160)	33.12' (10.06 m)
10' (3.0 m)			* 47520 (* 23290)	* 47520 (* 23290)	* 38940 (* 17450)	* 36820 (* 14900)	* 31060 (* 13970)	26800 (10870)	* 26600 (* 12000)	20570 (8330)	* 18500 (* 8340)	16810 (6790)	33.74' (10.28 m)
5' (1.5 m)			* 37470 (* 16870)	* 37470 (* 16870)	* 42580 (* 19190)	* 35250 (* 14180)	* 33330 (* 15030)	25850 (10440)	* 27840 (* 12580)	20030 (8090)	* 19780 (* 8900)	16630 (6680)	33.63' (10.26 m)
Ground Level			* 47080 (* 20730)	* 47080 (* 20730)	* 44130 (* 19990)	* 34390 (* 13770)	* 34560 (* 15650)	25230 (10150)	* 28420 (* 12890)	19660 (7910)	* 21860 (* 9800)	17060 (6830)	32.78' (10.03 m)
-5' (-1.5 m)	* 37920 (* 16320)	* 37920 (* 16320)	* 57320 (* 26160)	* 57320 (* 26160)	* 43540 (* 19820)	34120 (13620)	* 34340 (* 15620)	24970 (10010)	* 27740 (* 12650)	19550 (7850)	* 25240 (* 11250)	18290 (7280)	31.12' (9.55 m)
-10' (-3.0 m)	* 58130 (* 25370)	* 58130 (* 25370)	* 52410 (* 24050)	* 52410 (* 24050)	* 40690 (* 18640)	34320 (* 13690)	* 32090 (* 14720)	25110 (10060)			* 25940 (* 11760)	20760 (8210)	28.5' (8.79 m)
-15' (-4.5 m)	* 56450 (* 26290)	* 56450 (* 26290)	* 44170 (* 20510)	* 44170 (* 20510)	* 34590 (* 16070)	* 34590 (* 16070)	* 25590 (* 12090)	* 25590 (* 12090)			* 25460 (* 11600)	* 25460 (* 11600)	24.64' (7.65 m)
-20' (-6.0 m)			* 31420 (* 14280)	* 31420 (* 14280)							* 22790 (* 10360)	* 22790 (* 10360)	19.49' (5.94 m)

A Distance from center of rotation  
B Height

NOTE: Lifting capacities are in compliance with SAE 1097 and ISO 10567. Machine in lifting mode with power boost turned on. Load point is the end of the arm. Rated loads shown do not exceed 75% of minimum tipping loads or 87% of hydraulic capacities. Rated loads marked with an asterisk (\*) are limited by hydraulic capacities. The least stable position is over the side. The total mass of machine includes the mass of the boom, arm, counterweight, all operating fluids and 165 lb. (75 kg) operator.

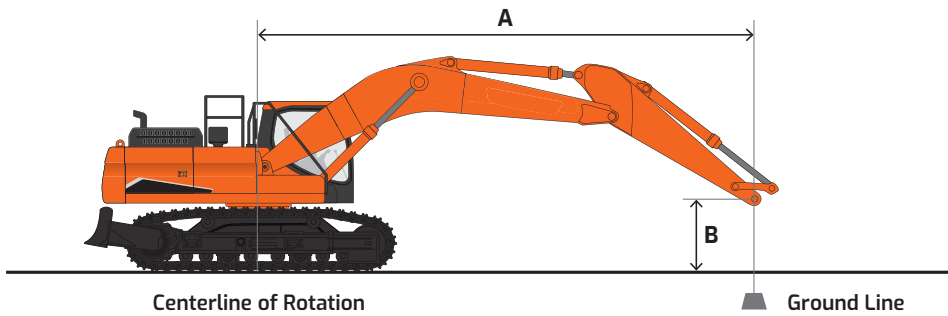













# Lifting Capacity

 Rating over front     Rating over side or 360°

## DX490LC-7 US25

Boom: 23' 4" (7100 mm) | Arm: 11' 0" (3350 mm) | Removable counterweight: 24420 lb. (11100 kg) | 35.4" (900 mm) TG Shoes | Bucket: None | Unit: lb. (kg)

A (ft. or m) B (ft. or m)	10' (3.0 m)		15' (4.5 m)		20' (6.0 m)		25' (7.5 m)		30' (9.0 m)		Max. Reach		
													A
30' (9.0 m)							* 23420 (* 10790)	* 23420 (* 10790)			* 18450 (* 8730)	* 18450 (* 8730)	25.62' (7.79 m)
25' (7.5 m)							* 24060 (* 11100)	* 24060 (* 11100)			* 17840 (* 8250)	* 17840 (* 8250)	29.11' (8.87 m)
20' (6.0 m)							* 25580 (* 11790)	* 25580 (* 11790)	* 23920 (* 11040)	19430 (8460)	* 17520 (* 8110)	17340 (7560)	31.52' (9.61 m)
15' (4.5 m)			* 44360 (* 20330)	* 44360 (* 20330)	* 33410 (* 15350)	* 33410 (* 15350)	* 28040 (* 12910)	25060 (10890)	* 25010 (* 11530)	18960 (8250)	* 17720 (* 8200)	15790 (6880)	33.01' (10.06 m)
10' (3.0 m)			* 51350 (* 23120)	49200 (21220)	* 38470 (* 17660)	32860 (14220)	* 30790 (* 14160)	23970 (10400)	* 26450 (* 12190)	18370 (7990)	* 18400 (* 8500)	14980 (6530)	33.71' (10.28 m)
5' (1.5 m)			* 37190 (* 16710)	* 37190 (* 16710)	* 42310 (* 19400)	31260 (13510)	* 33140 (* 15230)	23010 (9980)	* 27740 (* 12770)	17830 (7750)	* 19620 (* 9060)	14730 (6420)	33.68' (10.26 m)
Ground Level			* 45690 (* 20570)	* 45690 (* 20570)	* 44070 (* 20200)	30350 (13110)	* 34490 (* 15840)	22370 (9690)	* 28410 (* 12660)	17440 (7580)	* 21610 (* 9960)	15050 (6550)	32.9' (10.3 m)
-5' (-1.5 m)	* 35990 (* 16170)	* 35990 (* 16170)	* 57680 (* 26390)	46110 (19850)	* 43700 (* 20030)	30040 (12970)	* 34440 (* 15820)	22080 (9560)	* 27900 (* 12590)	17310 (7520)	* 24810 (* 11410)	16050 (6980)	31.33' (9.55 m)
-10' (-3.0 m)	* 55930 (* 25210)	* 55930 (* 25210)	* 53030 (* 24270)	* 46600 (* 20060)	* 41100 (* 18850)	30190 (13040)	* 32440 (* 14910)	22170 (9600)			* 25930 (* 11950)	18090 (7870)	28.83' (8.78 m)
-15' (-4.5 m)	* 57970 (* 26520)	* 57970 (* 26520)	* 45210 (* 20720)	* 45210 (* 20720)	* 35420 (* 16270)	30830 (13320)	* 26660 (* 12280)	22810 (9890)			* 25580 (* 11790)	22270 (9660)	25.1' (7.65 m)
-20' (-6.0 m)			* 31490 (* 14480)	* 31490 (* 14480)							* 22840 (* 10550)	* 22840 (* 10550)	19.48' (5.94 m)

A Distance from center of rotation  
B Height

NOTE: Lifting capacities are in compliance with SAE 1097 and ISO 10567. Machine in lifting mode with power boost turned on. Load point is the end of the arm. Rated loads shown do not exceed 75% of minimum tipping loads or 87% of hydraulic capacities. Rated loads marked with an asterisk (\*) are limited by hydraulic capacities. The least stable position is over the side. The total mass of machine includes the mass of the boom, arm, counterweight, all operating fluids and 165 lb. (75 kg) operator.

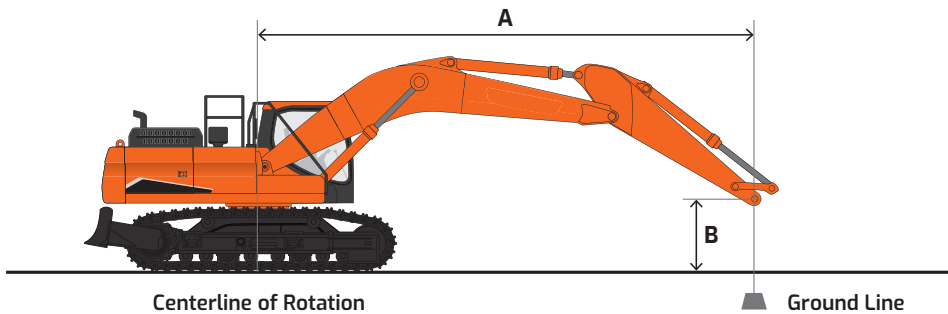

















# Lifting Capacity

 Rating over front    
  Rating over side or 360°

## DX490LC-7 US30

Boom: 23' 3" (7100 mm) | Arm: 13' 1" (3980 mm) | Removable counterweight: 24420 lb. (11100 kg) | 35.4" (900 mm) TG Shoes | Bucket: None | Unit: lb. (kg)

A (ft. or m) B (ft. or m)	5' (1.5 m)		10' (3.0 m)		15' (4.5 m)		20' (6.0 m)		25' (7.5 m)		30' (9.0 m)		35' (10.5 m)		Max. Reach		
																	A
30' (9.0 m)														* 16030 (* 7270)	* 16030 (* 7270)	25.62' (7.79 m)	
25' (7.5 m)												* 22080 * 10020	* 22080 * 10020	* 15360 (* 6970)	* 15360 (* 6970)	29.11' (8.87 m)	
20' (6.0 m)												* 24270 (11010)	* 24270 (11010)	* 22760 (* 10330)	* 22760 (* 10330)	31.52' (9.61 m)	
15' (4.5 m)							* 31760 (* 14410)	* 31760 (* 14410)	* 26980 (* 12240)	* 26980 (* 12240)	* 24180 (* 10970)	* 24180 (* 10970)	* 18410 (* 8350)	* 18410 (* 8350)	* 15430 (* 7000)	* 15430 (* 7000)	33.01' (10.06 m)
10' (3.0 m)				* 51770 (* 23480)	* 51770 (* 23480)	* 37140 (* 16840)	* 37140 (* 16840)	* 29990 (* 13600)	* 29990 (* 13600)	* 25870 (* 11740)	24860 (11280)	* 22760 (* 10320)	19770 (8970)	* 16040 (* 7270)	* 16040 (* 7270)	33.71' (10.28 m)	
5' (1.5 m)				* 48970 (* 22210)	* 48970 (* 22210)	* 41500 (* 18820)	* 41500 (* 18820)	* 32650 (* 14810)	31330 (14210)	* 27430 (* 12440)	24220 (10990)	* 23990 (* 10880)	19440 (8820)	* 17090 (* 7750)	* 17090 (* 7750)	33.68' (10.26 m)	
Ground Level				* 50780 (* 23040)	* 50780 (* 23040)	* 43940 (* 19930)	41910 (19010)	* 34400 (* 15600)	30550 (13860)	* 28440 (* 12900)	23740 (10770)	* 20430 (* 9270)	19220 (8720)	* 18750 (* 8510)	* 18750 (* 8510)	32.9' (10.3 m)	
-5' (-1.5 m)	* 28960 (* 13140)	* 28960 (* 13140)	* 36980 (* 16770)	* 36980 (* 16770)	* 59400 (* 26950)	* 59400 (* 26950)	* 44280 (* 20090)	41390 (18770)	* 34840 (* 15800)	30130 (13670)	* 28460 (* 12910)	23500 (10660)		* 21380 (* 9700)	20250 (9190)	31.33' (9.55 m)	
-10' (-3.0 m)	* 42010 (* 19060)	* 42010 (* 19060)	* 52520 (* 23820)	* 52520 (* 23820)	* 55670 (* 25250)	* 55670 (* 25250)	* 42460 (* 19260)	41390 (18780)	* 33550 (* 15220)	30090 (13650)	* 26690 (* 12110)	23580 (10690)		* 25100 (* 11380)	22530 (10220)	28.83' (8.78 m)	
-15' (-4.5 m)			* 65610 (* 29760)	* 65610 (* 29760)	* 48920 (* 22190)	* 48920 (* 22190)	* 37910 (* 17190)	* 37910 (* 17190)	* 29480 (* 13370)	* 29480 (* 13370)				* 25240 (* 11450)	* 25240 (* 11450)	25.1' (7.65 m)	
-20' (-6.0 m)					* 37310 (* 16920)	* 37310 (* 16920)	* 28350 (* 12860)	* 28350 (* 12860)						* 24040 (* 10910)	* 24040 (* 10910)	19.48' (5.94 m)	

A Distance from center of rotation  
B Height

NOTE: Lifting capacities are in compliance with SAE 1097 and ISO 10567. Machine in lifting mode with power boost turned on. Load point is the end of the arm. Rated loads shown do not exceed 75% of minimum tipping loads or 87% of hydraulic capacities. Rated loads marked with an asterisk (\*) are limited by hydraulic capacities. The least stable position is over the side. The total mass of machine includes the mass of the boom, arm, counterweight, all operating fluids and 165 lb. (75 kg) operator.

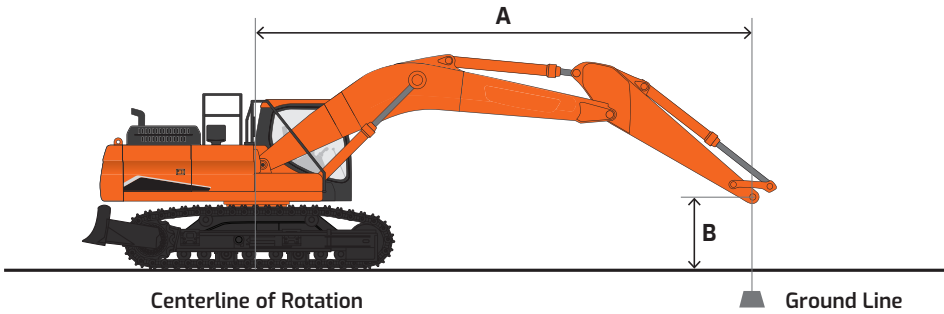

# Standard & Optional Equipment

■ Standard • Optional

## Engine

Emissions (EPA)	T4f
High-pressure common-rail (HPCR)	■
Variable geometry (VGT)	■
Cooled exhaust gas recirculation (CEGR)	■
Selective catalyst reduction (SCR)	■
Diesel exhaust fluid (DEF)	■
Fuel filter with water separator	■
Coolant expansion tank	■
Dual element dry-type air filter with evacuator	■
Precleaner	■
Electronic engine control (ECU)	■
Auto idle	■
Auto shutdown (time-adjustable)	■
Overheat & low oil pressure engine protection	■
Block heater (110 V)	•
Fuel filler pump	•

## Hydraulic

Electronic Power Optimizing System (EPOS)	■
Variable axial piston main pump (tandem)	■
Cross-sensing pump control	■
Pilot-operated control valves	■
Gear pilot pump	■
D-ECOPOWER	■
Smart Power Control (SPC)	■
Variable-speed hydraulic cooling fan	■
Axial piston swing motor	■
Spring-applied hydraulic release brake, swing motor	■
Axial piston travel motor (high/low, auto)	■
Auxiliary hydraulics, one- & two-way piping	■
Auxiliary hydraulics, tilt/rotate piping	•
Adjustable auxiliary flow & pressure, 10 presets	■
Intelligent floating boom	•
Breaker filter	•
Boom & arm lock valves	•
Straight travel	•

## Controls

Joystick controls	■
Pattern control change valve (SAE, ISO)	■
Joystick attachment control	■
Switches/buttons	■
- Right (one-way, two-way, power boost)	■
- Left (tilt/rotate, horn, one-touch decel)	■
Foot pedal attachment control	■
Control stands	■
- Height adjustable	■
- Sliding (fore/aft)	■
- Tilting armrests	■
Engine speed control dial	■
Travel pedals with hand levers	■
Straight travel pedal	•
Switches, console-mounted	■
- Starter button switch	■
- Travel speed selector	■
- Work light	■
- Auxiliary mode switch	■
Emergency stop switch	■
Power modes (P+, P, S, E)	■
Work modes (digging, lifting, breaker, shear)	■
Smart Power Control (SPC)	■
Jog dial display control	■
Bluetooth® control panel	■
Wiper control panel	■
Audio control panel	■

## Cabin

Steel, all-weather & sound-suppressed	■
ROPS (ISO 12117-2:2008)	■
Viscous mount with spring reinforcement	■
Front window with wiper/washer	■
Tinted safety glass	■
Skylight top hatch with sun screen	■
Front window with sun screen	■
Pull-up type top front window	■
Removable lower front window with storage behind seat	■
Adjustable sliding side door window	■
Defrost, front window	■
Lockable doors	■
Seat	■
- Heated	■
- Air suspension	■
- 2" (51 mm) seat belt	■
- Adjustable height & recline	■
- Adjustable fore/aft	■
- Adjustable armrests	■
Leatherette seat	■
- Heating & cooling	■
- Air suspension	■
- 2" (51 mm) seat belt	•
- Adjustable height & recline	■
- Adjustable fore/aft	■
- Adjustable armrests	■
3" (76 mm) seat belt	•
Control stands	■
- Height adjustable	■
- Mounted to seat base	■
Storage for operator's manuals	■
Mirrors	■
Fully automatic HVAC with ambient temperature sensor	■
8" multi-function LCD interactive display monitor	■
Cigarette lighter	■
Digital Bluetooth audio broadcasting MP3 radio with cell phone integration	■
Speakers (2)	■
Antenna, roof-mounted	■
Emergency breakout tool	■
Hot/cold beverage compartment	■
Power socket, 12 V & 24 V	■
Cup holder	■
Interior light	■
Coat hanger	■
Rain shield	•
Fog guard	•
Panto wiper, front windshield & lower window	■
Front window guard	•
Vandalism window cover mount	■

## Electrical

System voltage – 24 V	■
Alternator – 28 V, 100 amp	■
2 x 12 V batteries, 200 AH reserve capacity	■
Blade-type fuse panel	■
Main circuit breaker	■
Light, work (LED): machine (2), boom (2)	■
Light, work (LED): 6 cab top, front (4), rear (2)	•
Light, work (LED): 4 cab top, front (2), rear (2)	•
Rotating beacon	•
Hour meter	■
Engine restart prevention system	■
Side view & rearview camera with LED lamps (6)	■
360° all-around view camera	■
Ultrasonic sensor	■
Laptop service port	■
Self-diagnostics system	■
Smart key (remote ignition key)	■
DEVELON Fleet Management	■

## Display Monitor & Warnings

Indicators	■
- Work modes (P+, P, S, E)	■
- User/Service menu	■
Gauges	■
- Fuel level	■
- DEF level	■
- Engine coolant temperature	■
- Hydraulic oil temperature	■
- Engine rpm	■
- Battery voltage	■
- Hydraulic pump pressure	■
- ECO	■
- Digital clock	■
- Trip meter	■
- Hour meter	■
- Fuel consumption	■
Warning & indicator lights	■
- Seat belt	■
- Error code	■
- SCR warning	■
- Check engine	■
- Engine oil pressure	■
- Engine pre-heat engaged	■
- Radiator coolant level & temperature	■
- Air filter	■
- Fuel level	■
- DEF level – low	■
- Water in fuel	■
- Battery charge	■
- Work lights on	■
- Hydraulic oil temperature	■
- Hydraulic charge pressure	■
- Hydraulic pilot filter	■
- Hydraulic return filter	■
Swing alarm	■
Travel alarm	■
Buzzer	■
- Engine oil pressure	■
- Coolant temperature	■

## Undercarriage

Fixed track width	•
Retractable undercarriage frames	■
Track guards & chains with adjusters	■
Track rollers, upper	3
Track rollers, lower	9
In-shoe motor protection	■
Shoes, double grouser – 600 mm	•
Shoes, triple grouser – 600 mm	•
Shoes, triple grouser – 750 mm	•
Shoes, triple grouser – 800 mm	•
Shoes, triple grouser – 900 mm	■

## Frame

Counterweight, fixed	•
Counterweight, retractable	■
Catwalks	■

## Other

Centralized lubrication	■
- Boom	■
- Arm	■
- Swing	■
Handrails & service platforms	■
Skid-resistant steps & service platforms	■
Manuals	■
- Operation & Maintenance	■
- Parts	■
- AEM Safety Manual	■
DEVELON Fleet Management 3-year subscription	■
Vandalism protection	■
- Lockable panels	■
- Lockable fluid fill points	■
- Anti-theft protection (password)	■
- Vandalism window cover mount	■
Air compressor	•

Certain specification(s) are based on engineering calculations and are not actual measurements. Specification(s) are provided for comparison purposes only and are subject to change without notice. Specification(s) for your individual DEVELON equipment will vary based on normal variations in design, manufacturing, operating conditions, and other factors. Pictures of DEVELON units may show other than standard equipment.

# Powered by Innovation

# DEVELON

A brand of HD Hyundai Infracore.

[na.develon-ce.com/dx490lc-7](http://na.develon-ce.com/dx490lc-7)

DX490LC-7 Crawler Excavator Spec Sheet  
Printed in the U.S.A.  
23906\_002\_D070723

©2023 HD Hyundai Infracore. All rights reserved.